

Cross-cut A-A

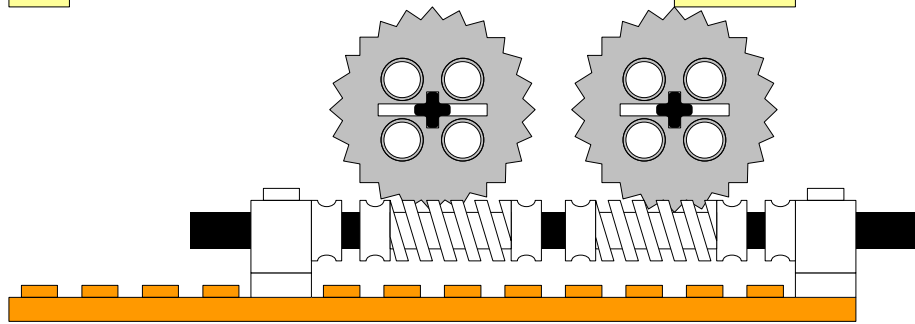

Cross-cut B-B

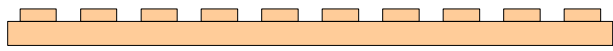
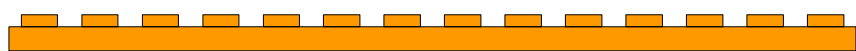
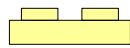
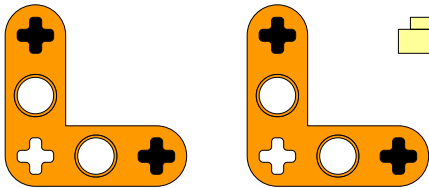
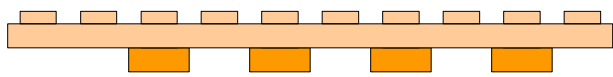

Cross-cut C-C

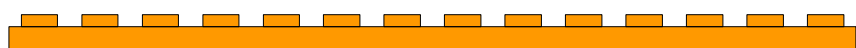
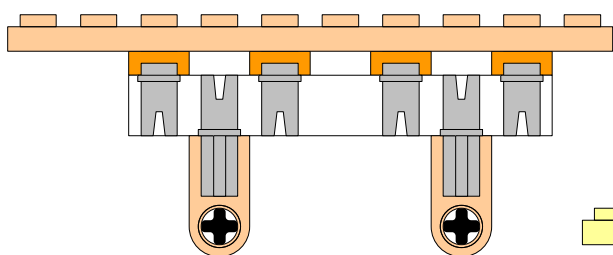

Cross-cut D-D

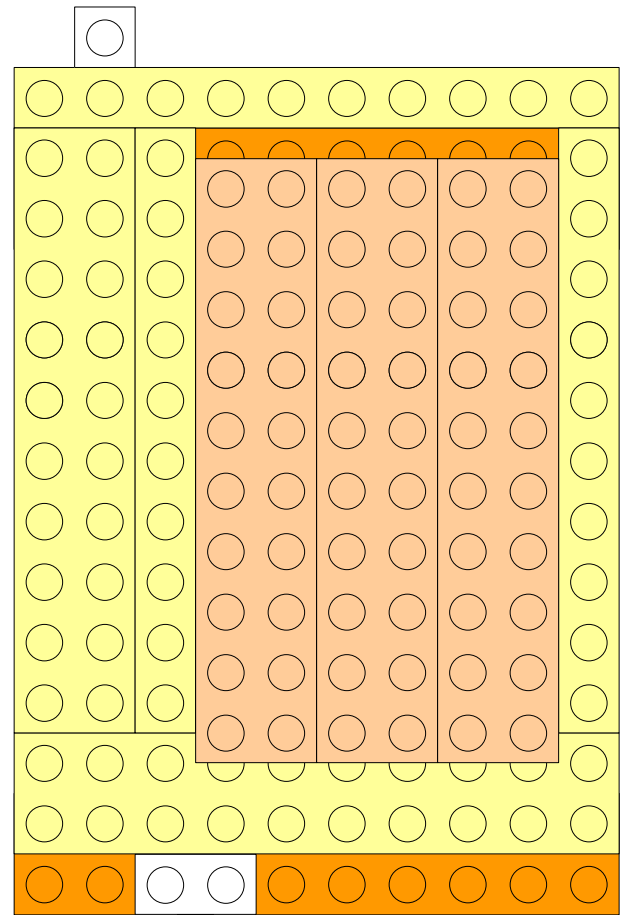

Top view

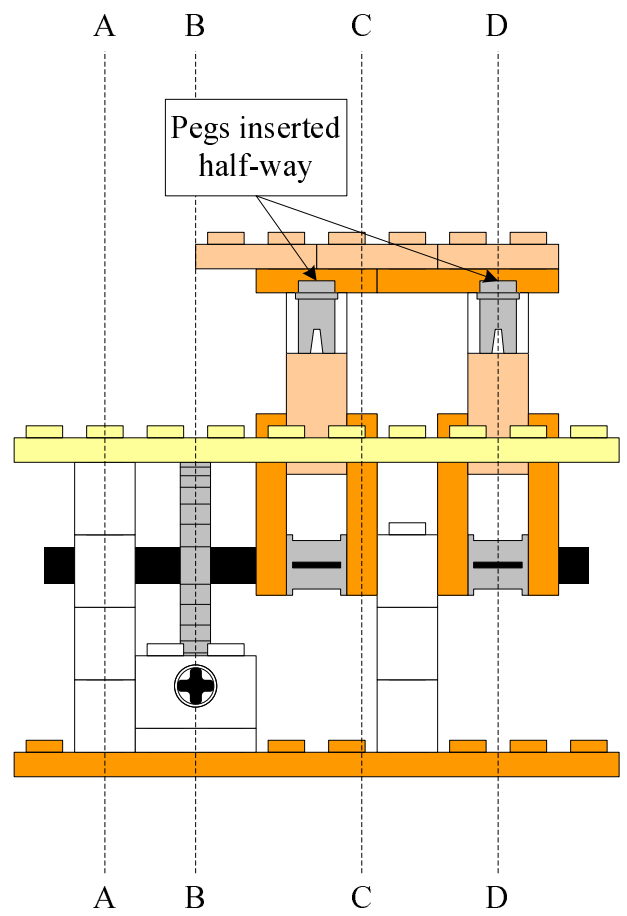

Side view

This drawing shows main geometry (i.e. several pieces omitted)

*Part: lid*

*Robot: Don't Push*

*Date: 2010 aug 2*

*Author: Maarten Pennings*

*Page: 1/2*

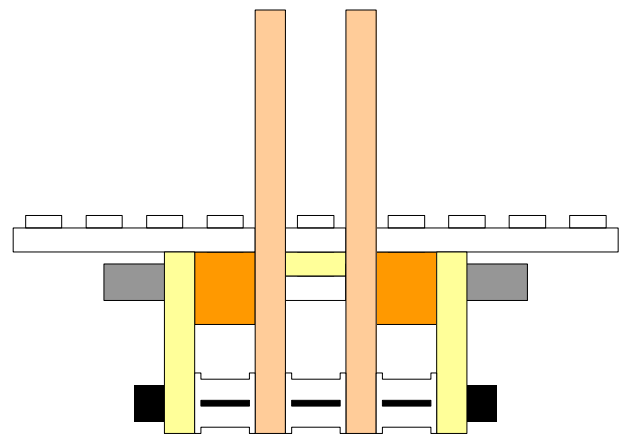

Front view

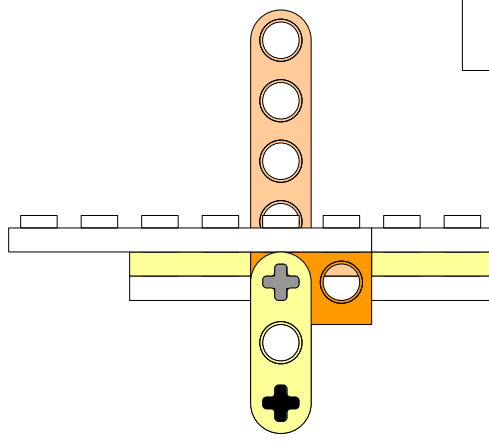

Side view

2-by-1 plate with  
single stud inserted  
half-way

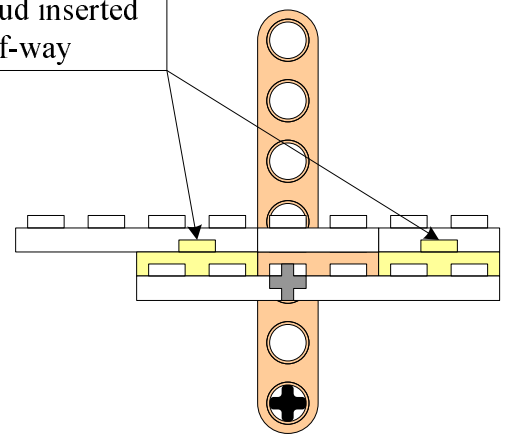

Cross-cut A-A

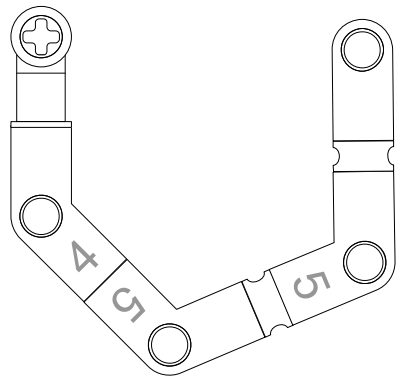

Pin

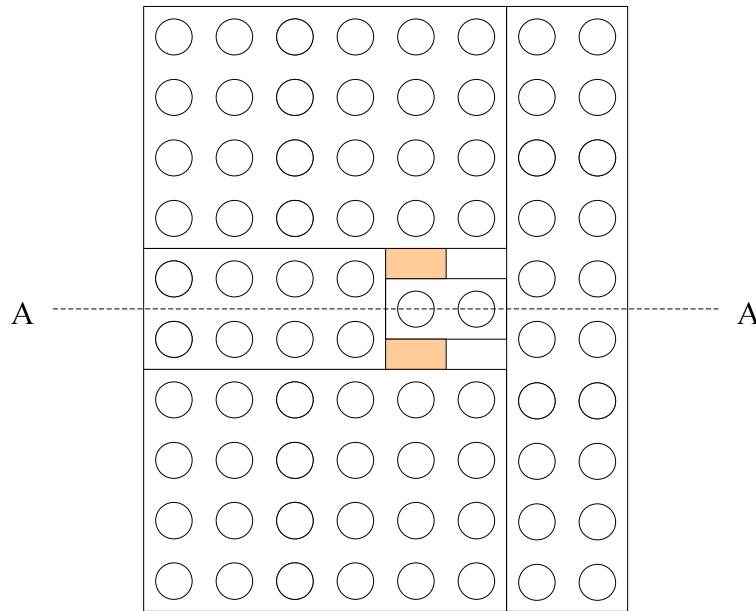

Top view

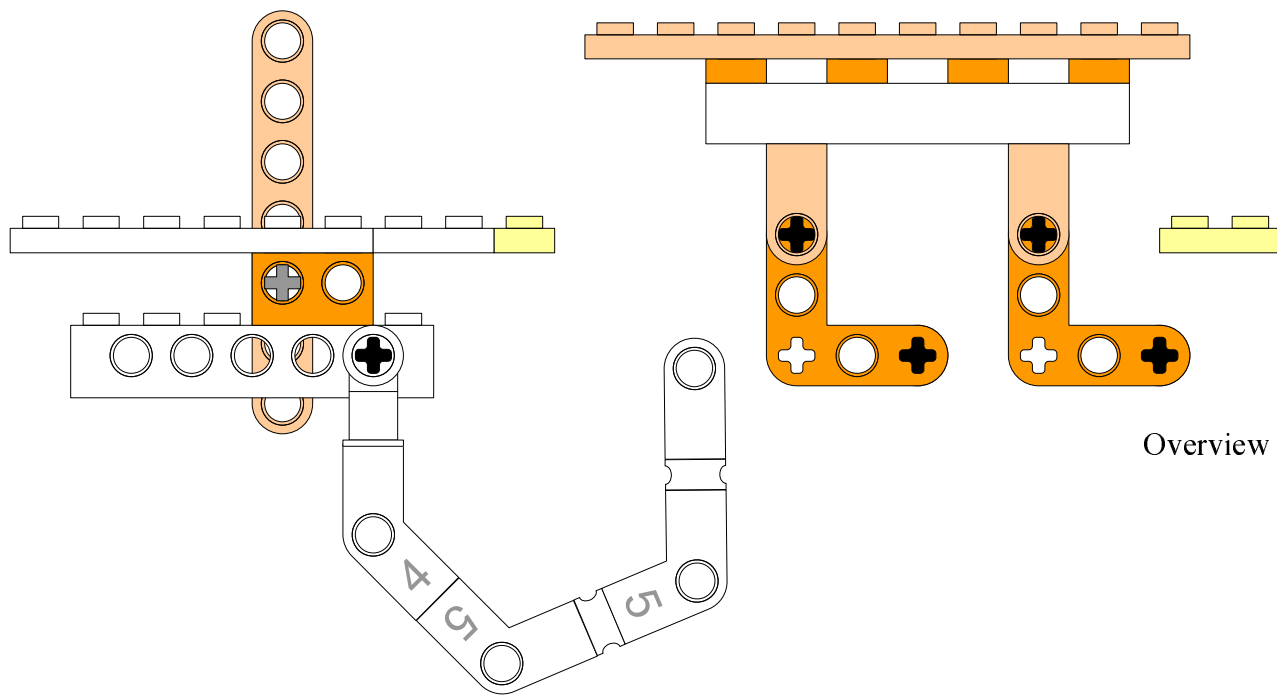

Overview

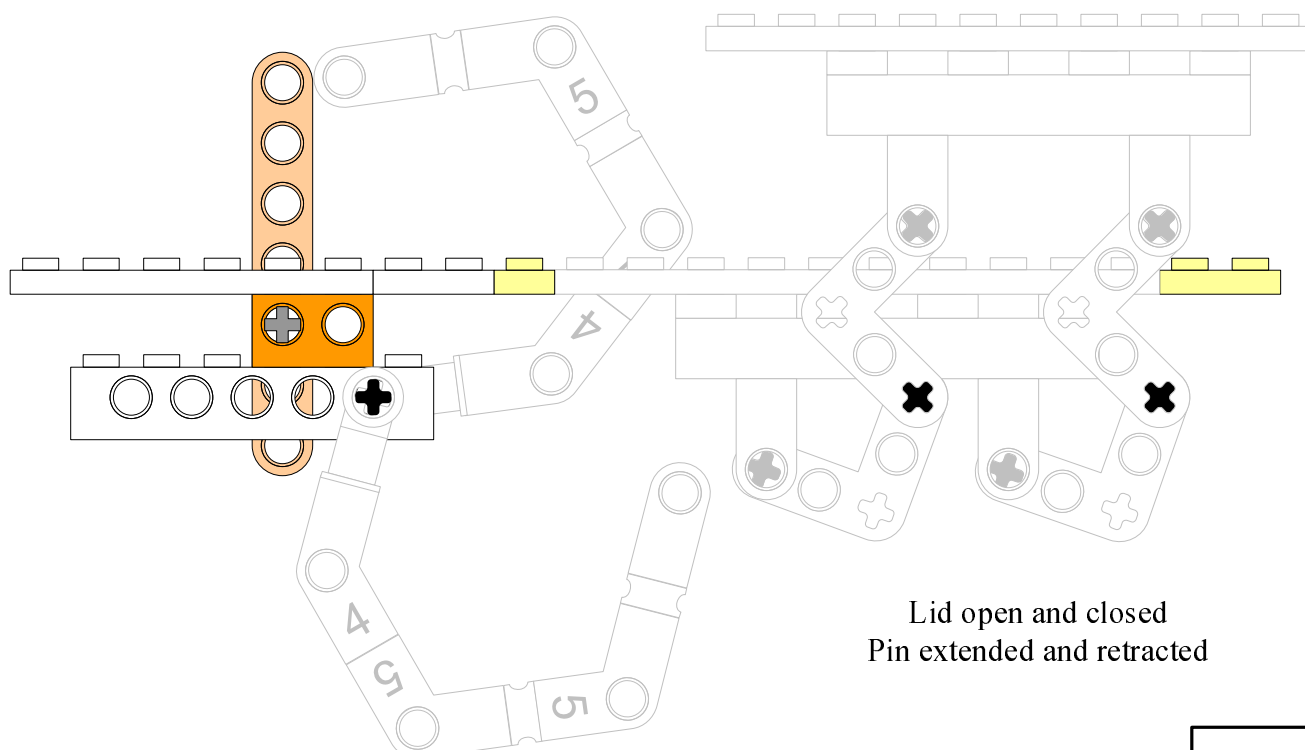

Lid open and closed  
Pin extended and retracted

*Part: person, pin and overview*

*Robot: Don't Push*

*Date: 2010 aug 2*

*Author: Maarten Pennings*

*Page: 2/2*